

# EBC22

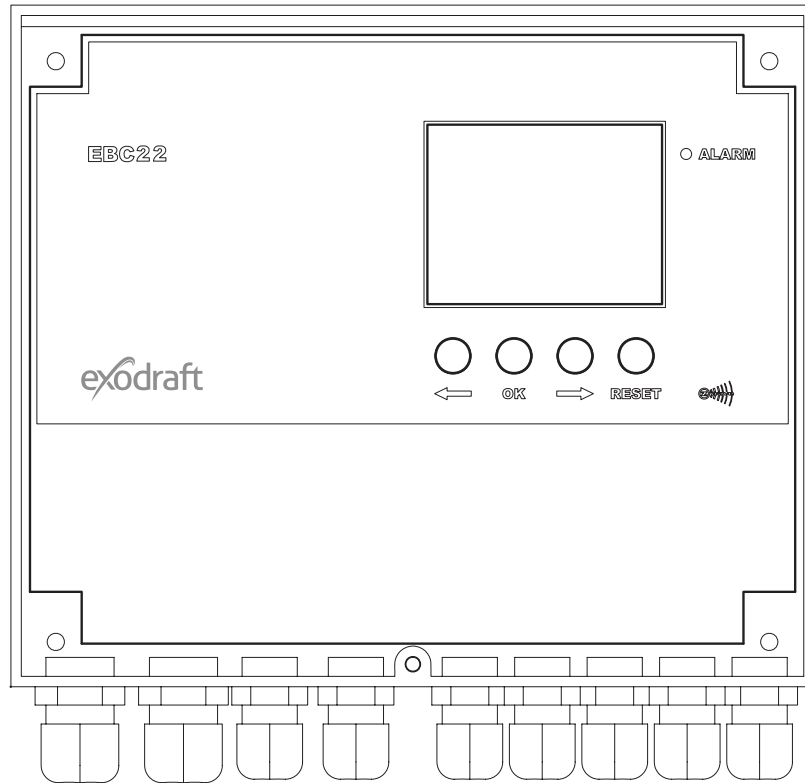

## Instructions for fitting, installation and operation

UK

Read and save these instructions!

**exodraft**

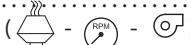
<b>1.</b>	<b>Product information</b>	<b>4</b>
1.1	Delivery	4
1.2	Accessories	5
1.3	Fitting	5
1.3.1	Cable length	5
1.3.2	Connection diagram	6
1.4	Layout of the user interface	7
1.4.1	Panel	7
1.4.2	Light emitting diodes and terminal board	8
1.4.3	Display	9
1.5	Introduction to the user interface	10
1.6	Set-up	10
1.6.1	Setting the chimney draft	10
1.7	Service menu	11
1.7.1	Overview of the service menu	12
1.7.2	Changing between the operating functions 	14
<b>2.</b>	<b>Pressure-controlled regulation of the chimney fan</b>	<b>15</b>
2.1	Use	15
2.2	Method of operation	15
2.3	Electrical connection	15
2.4	Sample wiring diagrams	16
2.4.1	Single- or two boiler application	17
2.4.2	Single boiler application with potential free contact in boiler	18
2.4.3	2 boiler application with continuous operation of chimney fan	19
2.4.4	Solid fuel boiler with temperature sensor	20
2.5	User menu	21
2.5.1	Layout of the user menu	21
2.5.2	Operating the user menu	21
2.6	Set-up	21
2.7	Commissioning	22
<b>3.</b>	<b>2-stage speed regulation of exodraft chimney fan</b>	<b>23</b>
3.1	Use	23
3.2	Method of operation	23
3.3	Electrical connection	23
3.4	Sample wiring diagrams	23
3.4.1	1 x 2-stage boiler	24
3.4.2	2 x 1-stage boilers	25
3.5	User menu	26
3.5.1	Layout of the user menu	26
3.5.2	Operating the user menu	26
3.6	Set-up	27
3.6.1	Setting the chimney fan output	27
3.7	Commissioning	28
<b>4.</b>	<b>Pressure-controlled regulation of exodraft supply air fan</b>	<b>29</b>
4.1	Use	29
4.2	Method of operation	29
4.3	Electrical connection	29
4.4	Sample wiring diagram	29
4.4.1	Connection of frequency converter/MPR relay	30
4.5	User menu	31
4.5.1	Operating the user menu	31
4.6	Set-up	32
4.7	Commissioning	32
<b>5.</b>	<b>List of alarms and troubleshooting</b>	<b>33</b>
5.1	Alarm handling	33
5.1.1	Resetting a current alarm	33
5.1.2	Resetting the alarm log	33
5.1.3	Alarm overview	33
5.2	More troubleshooting	35
5.2.1	Program running	35
5.2.2	Communication error	35
<b>6.</b>	<b>Technical specifications</b>	<b>36</b>
<b>7.</b>	<b>EU declaration of conformity</b>	<b>37</b>

**Symbol Legend:** The following terms are used throughout this manual to bring attention to the presence of potential hazards or to important information concerning the product.

**Prohibition symbol:**  Failure to observe instructions marked with a prohibition symbol may result in serious injury or death.

**Danger symbol:**  Failure to observe instructions marked with a danger symbol may result in personal injury and/or damage to the unit.



**TO REDUCE THE RISK OF FIRE, ELECTRICAL SHOCK OR INJURY TO PERSONS, OBSERVE THE FOLLOWING:**

- Use this unit in the manner intended by the manufacturer. If you have questions, contact the supplier at the address or telephone number listed on the back of the manual.
- Before servicing or cleaning the unit, switch off at service panel and lock service panel to prevent power from being switched on accidentally.
- Installation work and electrical wiring must be done by a qualified person(s) in accordance with applicable codes and standards.
- Follow the appliance manufacturer's guidelines and safety standards and the local code authorities
- This unit must be grounded.

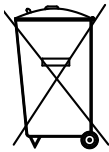

No special requirements. Disposal should be carried out in accordance with statutory regulations related to the disposal of electronic waste.



# 1. Product information

## Description

The EBC22 (**exodraft** Boiler Control) is a specially designed control component for constant pressure regulation of chimney draft. EBC is specially designed to comply with the Gas Application Directive.

By changing the operating mode, the EBC22 can also:

- Act as a 2-stage speed regulator (see section 3)
- Control the supply of fresh air to the boiler room (see section 4)
- Automatically start/stop via a temperature sensor in the chimney duct

## Layout of the instructions

The EBC22 can control an **exodraft** chimney fan or an **exodraft** supply air fan.

### There are seven sections to the instructions:

- Read section 1. "Product information"
- Read the section that deals with the required control methods:
  - ♦ Section 2: Pressure-controlled regulation of **exodraft** fans (factory-set)
  - ♦ Section 3: Two-step speed regulation of **exodraft** fans
  - ♦ Section 4: Pressure-controlled regulation of **exodraft** supply air fan
- Read sections 5–7.

Section 2,3, and 4 deal with the following:

### Section 2:

- Pressure-controlled regulation of **exodraft** chimney fans (default).
- The EBC22 ensures and monitors constant pressure in a chimney.
- The EBC22 is designed for use with boiler systems with 1- and 2-stage burners.
- The EBC22 can also be used for boiler systems with modulating burners.
- The control system monitors chimney draft and shuts down the burner in the event of errors (the alarmdiode on the EBC22 will turn on).
- The control system is intended for both solid fuel boilers, atmospheric gas boilers, condens and forced draft boilers for oil and gas.
- The EBC22 can control a chimney fan directly or indirectly via a frequency converter.

### Section 3:

- 2-stage speed regulation of **exodraft** chimney fans.
- The EBC22 can be used as a 2-stage speed regulator for **exodraft** chimney fans.
- The EBC22 monitors chimney draft and shuts down the burner in the event of errors (the alarmdiode on the EBC22 will turn on).
- The control system is intended for 1- or 2-stage atmospheric gas boilers.
- The EBC22 can control a chimney fan directly or indirectly via a frequency converter.

### Section 4:

- Pressure-controlled regulation of **exodraft** supply air fans.
- The EBC22 can be used to control an **exodraft** BESB or BESF box fan.
- The EBC22 ensures and monitors constant pressure in a boiler room.
- The control system monitors the pressure in the boiler room and shuts down the burner in the event of errors (the alarmdiode on the EBC22 will turn on).
- The EBC22 can control a supply air fan directly or indirectly via a frequency converter.

## 1.1 Delivery

The EBC22 is delivered with the following:

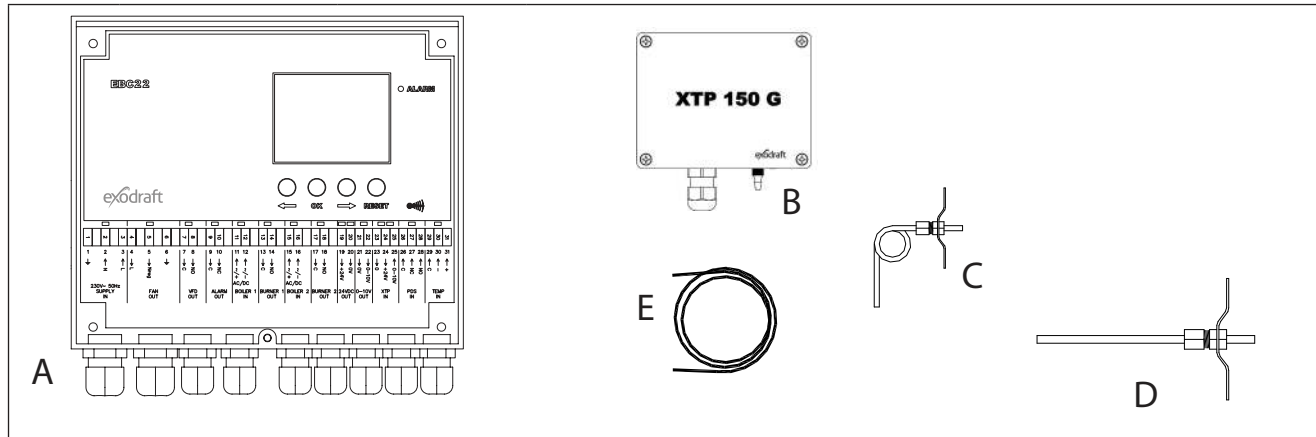

Pos.	Part	Item no.	Function
A	EBC22	EBC22EU01	Controls <b>exodraft</b> fans and chimney fans. For indoor installations.
		EBC22EU02	Controls <b>exodraft</b> fans and chimney fans. For outdoor installations.
B	Pressure transducer (XTP)	XTP150G	Measures difference air pressure in the boiler room or chimney, or outdoor atmospheric pressure.
C	Measuring probe for EBC22EU01	0500512	Measures pressure in the chimney. (EBC22EU01)
D	Measuring probe for EBC22EU02	3200484	Measures pressure in the chimney. (EBC22EU02)
E	2 m silicone hose	2000335	Supplies the pressure transducer (XTP) with reference pressure from the measuring probe or from outdoors.
	Instructions	3110009	Instructions for fitting, installation and operation.

## 1.2 Accessories

Part	Item no.	Function
Temperature sensor	1100755	Measures the temperature
Relay box	ES12	If more than 2 boilers are connected

## 1.3 Fitting

### 1.3.1 Cable length

Max. cable length between EBC22 and XTP: 100 m.



Max. cable length between EBC22 and chimney fan / fan: 100 m

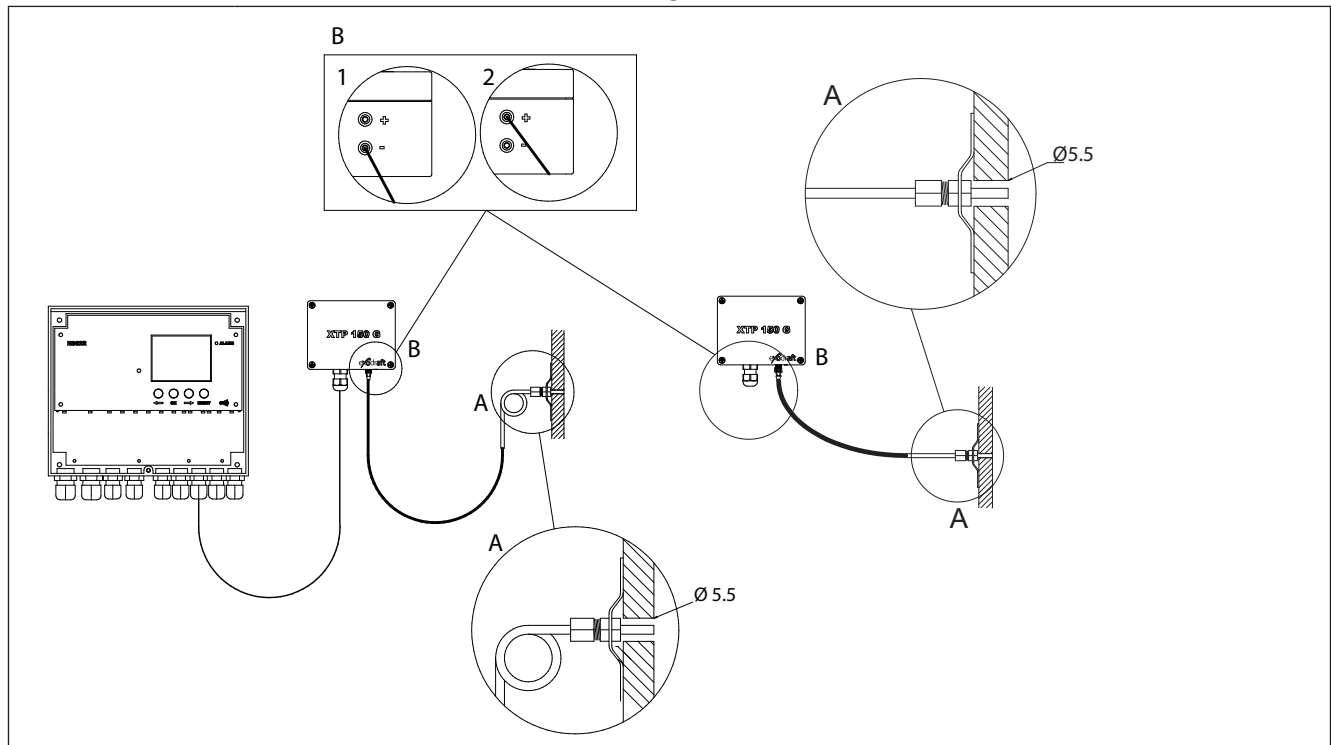

### 1.3.2 Connection diagram

The EBC22 is to be fitted and connected as shown in the diagram below.



Control of ...	Fitting procedure
Chimney fan  <b>Remark!</b>	<ul style="list-style-type: none"> <li>Fit the EBC22 and the pressure transducer (XTP) in the boiler room.</li> <li>Fit the measuring probe(A) in the boiler flue or in the manifold. However, for atmospheric boilers, the probe must always be positioned <u>after</u> the draft hood.</li> <li>Connect the hose from the measuring probe to the negative terminal on the pressure transducer (B''1'').</li> <li>When the measuring probe is placed outside it must be mounted in a way that prevents condence or ice to be formed. EBC22EU02 is delivered with a straight measuring probe. If necessary the probe delivered with EBC20EU01 can be straightened and placed so the condens can run out.</li> <li>EBC20 must always be mounted in a way that protects it from the weather (Rain, snow etc.).</li> </ul>
Supply air fan 	<ul style="list-style-type: none"> <li>Fit the EBC22 and pressure transducer (XTP) in the boiler room.</li> <li>Connect the hose for measuring reference pressure (outdoor atmospheric pressure) to the negative terminal (B''1'') on the pressure transducer. Run the hose outside the building to a place that is not affected by wind, rain, etc. If appropriate, fit the free end of the hose in a box as described at the top of the next page.</li> </ul>
Note	<ul style="list-style-type: none"> <li>Special aspects if you require <b>positive pressure*</b> in the chimney/boiler room:</li> <li>Connect the hose to the positive terminal on the pressure transducer (B''2'')</li> <li>In menu 16 (see page 12) set the value to 2 (positive pressure). For operation of the service menu, see page 11</li> <li>Please note that the EBC22 is supplied with only 2 m of hose.</li> </ul>

**NB!**



**\*The default setting of the EBC22 is for negative pressure regulation, but local authority requirements may state that positive pressure must be maintained.**



**The pressure transducer cannot be mounted inside an air tight enclosure. It uses the atmospheric pressure as reference pressure.**

 **Make sure to position the pressure transducer the right way up.**

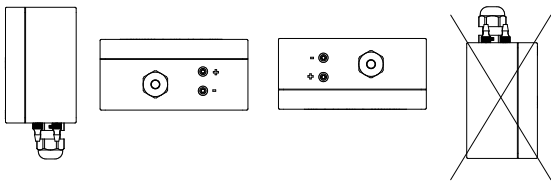

### Outdoor fitting of the pressure transducer (XTP)

If there is a risk of adverse effect from strong winds, the hose (A) located inside the XTP 150G can be removed from the (+) valve.

If the pressure transducer is positioned in a place where insects have access to the free end, fitting a sinter filter is recommended.

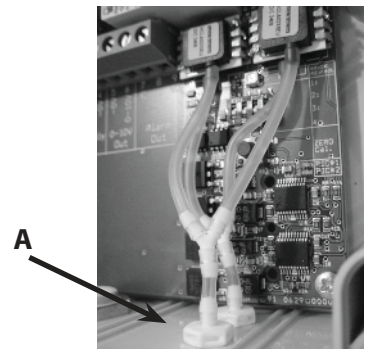



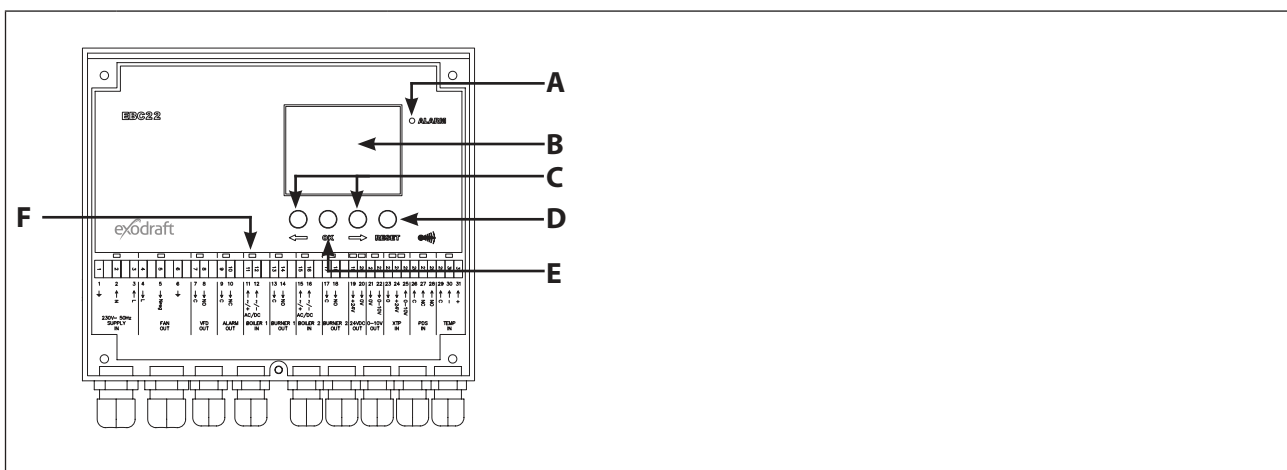

 **Do not blow into the valves on the XTP 150 G**

## 1.4 Layout of the user interface

### 1.4.1 Panel



Pos.	Part	Function
A	Alarm	<ul style="list-style-type: none"> <li>indicates alarms</li> </ul>
B	Display	<ul style="list-style-type: none"> <li>displays operation and changes in the user interface (menu system)</li> <li>indicates alarms</li> <li>shows normal operation status</li> </ul>
C	 and 	<ul style="list-style-type: none"> <li>forward or back in the menu system</li> <li>increase/reduce set point</li> </ul>
D		<ul style="list-style-type: none"> <li>reset alarm</li> <li>return to operation screen</li> </ul>
E		<ul style="list-style-type: none"> <li>select menu item</li> <li>confirm/save change of set point (must be confirmed with OK (the current set point blinks rapidly) and is saved using OK within 5 seconds (or the setting will not be saved)</li> </ul>
F	Light emitting diodes	<ul style="list-style-type: none"> <li>shows status of inputs and outputs</li> </ul>



### 1.4.2 Light emitting diodes and terminal board

The chart below lists the connection options for the terminal boards and explains the various colours of the light emitting diodes.

		●			●			●	●			●			●			●	●	●			●	●			●			●
1	2	3	4	5	6	7	8	9	10	11	12	13	14	15	16	17	18	19	20	21	22	23	24	25	26	27	28	29	30	31
1	2	3	4	5	6	7	8	9	10	11	12	13	14	15	16	17	18	19	20	21	22	23	24	25	26	27	28	29	30	31
⊥	↑	↑	↓	↓	⊥	↓	↓	↓	↓	↑	↑	↓	↓	↑	↑	↓	↓	↓	↓	↓	↓	↓	↑	↑	↑	↑	↑	↑	↑	↑
230V~ 50Hz SUPPLY IN				FAN OUT			VFD OUT	ALARM OUT		BOILER 1 IN		BURNER 1 OUT		BOILER 2 IN		BURNER 2 OUT		24VDC OUT		0-10V OUT		XTP IN	PDS IN		TEMP IN					

No.	Designation	Max. load	Meaning when the light diode is ...
1, 2 & 3	SUPPLY IN	230-240 V AC +/- 10 %	green: the EBC22 is connected to a power supply
4, 5 & 6	FAN OUT	3 A	green: the triac output is active
7 & 8	VFD OUT	250 V AC, 8 A, AC 3	green: the relay is connected
9 & 10	ALARM OUT	250 V AC, 8 A, AC 3	red: the relay is open
11 & 12	BOILER 1 IN	18 - 230 V DC / V AC	green: the input is active
13 & 14	BURNER 1 OUT	250 VAC, 4 A, A C 3	green: the relay is connected
15 & 16	BOILER 2 IN	18 V DC/230 V AC	green: the input is active
17 & 18	BURNER 2 OUT	250 V AC, 4 A, AC 3	green: the relay is connected
19 & 20	24 VDC OUT	100 mA	green: power supply OK red: overload
21 & 22	0 - 10 V OUT*	20 mA	green: the output is active
23, 24 & 25	XTP IN		green: XTP connected red: return voltage >12 V DC
26, 27 & 28	PDS IN **		green: C & NO are connected
29, 30 & 31	TEMP IN		green: temperature sensor connected

\* Cable length between 0-10 V output (terminal 21 & 22) must not exceed 100 m and must be of a shielded cable 3 x 0,75 mm<sup>2</sup>.

\*\* Terminals 26, 27 & 28 can however also be used for connecting other auxiliary surveillance equipment.



### 1.4.3 Display

The diagram below shows the layout of the display on the EBC22. All possible display values are stated:

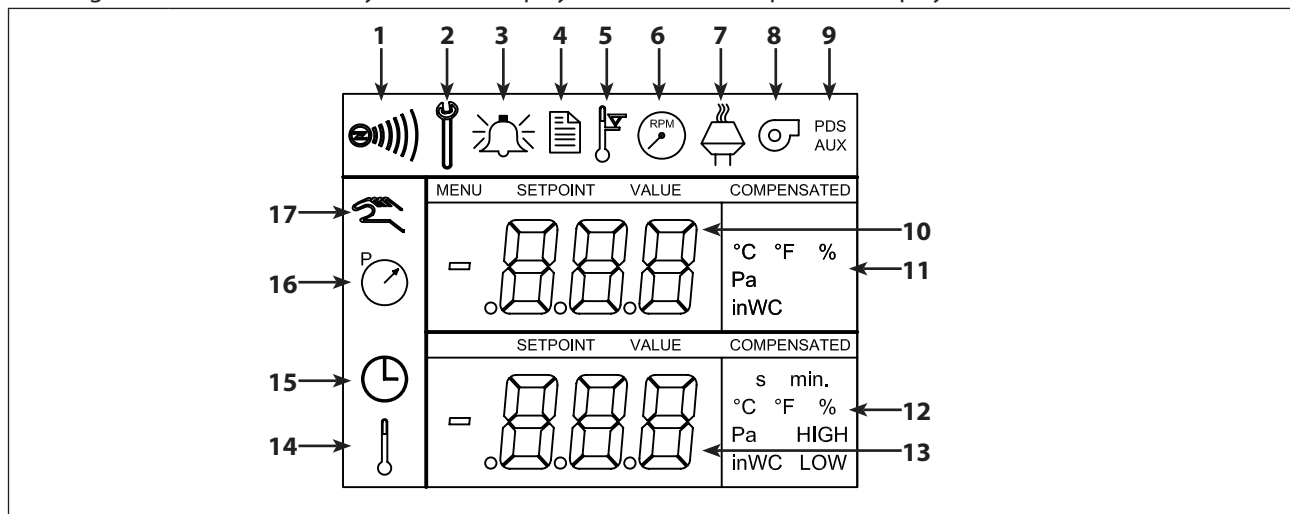

Pos.	Shows ...
1	Symbol indicating the connection of Z-wave
2	Symbol for service menu
3	Symbol for alarms. Displayed in the event of an alarm, along with the illumination of the alarm diode.
4	Symbol for the operational settings of the service menu (see section 1.6) and the alarm log.
5	Symbol for overheating
6	Symbol for 2-stage speed regulation of <b>exodraft</b> chimney fan
7	Symbol for pressure-controlled regulation of <b>exodraft</b> chimney fan
8	Symbol for pressure-controlled regulation of <b>exodraft</b> supply air fan
9	Symbol indicating: <ul style="list-style-type: none"> <li>• PDS error</li> <li>• PDS check (flashing)</li> </ul>
10	<ul style="list-style-type: none"> <li>• Operation screen: current pressure</li> <li>• Menu screen: current menu</li> </ul>
11	Units
12	Units
13	Menu screen ("VALUE" and, in some cases, "SETPOINT" displayed): Setpoint for the menu item in question
14	Temperature symbol, indicates: <ul style="list-style-type: none"> <li>• Operation screen: current temperature</li> <li>• Menu screen: temperature parameter setting</li> </ul>
15	Timer indicator
16	Pressure symbol indicating that: <ul style="list-style-type: none"> <li>• Operation screen: Pos. 10 is displaying pressure</li> <li>• Menu screen: You are currently altering a pressure parameter</li> </ul>
17	Symbol for commissioning

## 1.5 Introduction to the user interface

### Display

The purpose of the display (see previous page) is to present:

- Operating information (pressure, etc.)
- Alarms
- Setpoints
- Parameters





### Menu structure

The menu system in the EBC22 contains:

- User menu (for operation by daily users).
- Service menu (for operation by qualified technical staff).

### Layout of the user interface







The user interface is operated through four buttons with the following functions:

Button	Function
	<ul style="list-style-type: none"> <li>• Activate the user menu</li> <li>• Edit and save settings</li> <li>• Activate service menu (press and hold for 3 seconds)</li> </ul>
 and 	<ul style="list-style-type: none"> <li>• Go to menu item, and adjust value</li> </ul>
	<ul style="list-style-type: none"> <li>• Return to operation screen from any point in the menu system</li> <li>• Reset alarm when manual reset is selected in menu 25, see page 12</li> </ul>

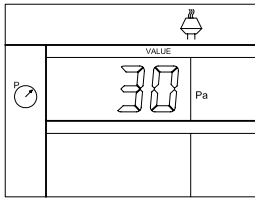
## 1.6 Set-up

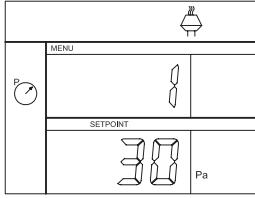
### 1.6.1 Setting the chimney draft

To set the pressure in the chimney, follow the procedure detailed below

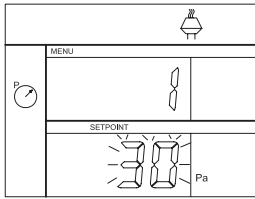
Step.	Action...	The display shows...
1	<ul style="list-style-type: none"> <li>• Start the heating system.</li> <li>• The EBC22 displays the actual pressure (in this example 30 Pa).</li> </ul>	
2	<ul style="list-style-type: none"> <li>• Briefly press  to enter the user menu.</li> </ul>	
3	<ul style="list-style-type: none"> <li>• Press </li> <li>• Press  and  until the required pressure appears in the lower display.</li> </ul>	

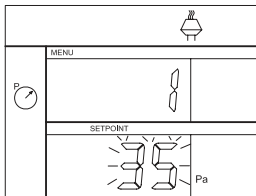
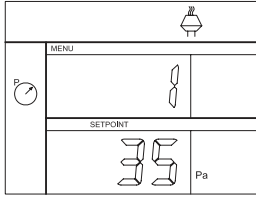
4	<ul style="list-style-type: none"> <li>Press <b>OK</b> to confirm the setting (the display blinks faster)</li> </ul>	
5	<ul style="list-style-type: none"> <li>Within 5 seconds, press <b>OK</b> again, to save the set pressure (35 Pa in this example).</li> </ul>	
6	To finish and return to the operation screen, press <b>RESET</b>	

**NB**

This procedure only applies to setting up the chimney draft.

If you wish to:

- Set the EBC22 up for 2-stage speed regulation of a chimney fan, see page 23
- Set the EBC22 up for pressure control of a supply air fan, see page 29

## 1.7 Service menu



The service menu is only to be operated by qualified staff.

For an overview of the **service menu**, see page 12 - 13

Operation of the **user menus** is described in sections 2, 3 and 4.

Navigation in the service menu

- To activate the service menu, press and hold **OK** for 3 seconds

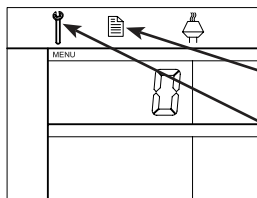

The service menu operation settings

Service menu









Operation is carried out using the buttons as described above.



- The upper display (pos. 10 on page 9) presents the number of the menu, with the set point for this menu being shown in the lower display (pos. 13 on page 9).
- Menus whose last digit is "0" are exit menus. These are used to navigate one level back. To do so, press **OK**
- To activate the editing options for a menu item, press **OK**. The set point will start flashing.
- Confirm selection with **OK**.
- Save by pressing **OK** again within 5 seconds.
- To exit the service menu, press **RESET**. This will take you back to the operation screen. Alternatively, you can navigate back one level at a time if you wish to set multiple menu items.

For examples of how to use the service menu, see 1.7.2 on page 14

### 1.7.1 Overview of the service menu

The service menu is built up in four levels:

Menu level 1	Menu level 2	Menu level 3	Function	Base settings for the three applications			
				 Default			
0 Exit Service menu			Return to operation screen				
1 Operation settings	10 Exit operation settings						
	11 Operating mode		Setting of control/operating function 1 = Pressure-controlled regulation  2 = 2-stage speed regulation  3 = Supply air regulation 	1			
	12 °C / °F		Select measuring unit for temperature 1 = °C, 2 = °F	1 (°C)	1 (°C)	1 (°C)	
	13 Pa / inWC		Measuring unit for pressure: 1 = Pa, 2 = inWC	1 (Pa)	1 (Pa)	1 (Pa)	
	14 Software versions	140 Exit					
		141 Controller version	View Controller software version	x.xx	x.xx	x.xx	
		142 Safety version	View Safety software version	x.xx	x.xx	x.xx	
		143 Display version	View Display software version	x.xx	x.xx	x.xx	
	15 Select XTP measurement range	150 Exit					
		151 Set Low XTP value	from -500 Pa to 0 Pa	0 Pa	N/A	0 Pa	
		152 Set High XTP value	from 0 Pa to 500 Pa	150 Pa	N/A	150 Pa	
	16 Positive/negative pressure		1 = negative pressure 2 = positive pressure	1	N/A	1	
	17 OEM functions	170 Exit					
171 Cooker function		Switch Cooker function ON and OFF	N/A	OFF	N/A		
18 Reset to defaults		Reset to defaults. If you select "YES", a 10-second countdown will start, during which you can cancel your choice by pressing any button.	NO	NO	NO		
2 Alarm	20 Exit Alarm						
	21 Alarm Log	210 Exit					
		211-219	The 9 most recent alarms				
	22 Reset alarm log		Resets alarm log	NO	NO	NO	
	23 Flow Alarm limit		Set Flow Alarm limit in %:  : 50-80% ( Alarm when pressure is below xx% )  : 100-300% ( Alarm when pressure is above xx% )	64%	N/A	300%	
	24 Flow Alarm delay		Set Flow Alarm delay, 10-60 s	15 s	15 s	15 s	
25 Reset auto / manual		1 = automatic, 2 = manual	1 (Auto)	1 (Auto)	11 (Auto)		

				Base settings for the three applications			
Menu level 1	Menu level 2	Menu level 3	Function	 Default			
3 Configuration	30 Exit settings						
	31 PDS/AUX config		1 = PDS, 2 = C-NO	2 (C-NO)	1 (PDS) (Locked)	2 (C-NO)	
	32 Triac settings	320 Exit					
		321 Umin		Min. output voltage in % of 230V AC, 35-100%	35%	N/A	35%
		322 Umax		Max. output voltage in % of 230V AC, 35-100%	100%	N/A	100%
	33 0-10V settings	330 Exit					
		331 Umin		Min. output voltage in % of 10V DC, 0-100%	0%	N/A	0%
		332 Umax		Max. output voltage in % of 10V DC, 0-100%	100%	N/A	100%
	34 Manual Fan mode	340 Exit					
		341 Manual Fan mode on/off		Switch Manual Fan mode on and off	OFF	OFF	OFF
		342 Manual Fan mode speed		Set the motor manually, 35-100%	35%	35%	35%
	35 Regulation parameters	350 Exit					
		351 Amplification Xp		Set proportional amplification, 0.2 to 5	2,2	N/A	1,2
		352 Integration time Ti		Set integration time from 1 to 30 s	5	N/A	3
353 Differential time Td			Set differential time from 1 to 30 s	1	N/A	5	
354 Sample time			Set sample time from 1 to 999 ms	300 ms	N/A	300 ms	
4 Temp. sensor	40 Exit Temp. sensor						
	41 Sensor ON/OFF		turn temperature sensor ON/OFF	OFF		OFF	
	42 Auto Start/Stop	420 Exit					
		421 ON/OFF		turn temperature sensor ON/OFF	OFF		OFF
		422 Start temperature		select start temperature in 5-450 °C range	40 °C		40 °C
		423 Stop temperature		select stop temperature in 0-445 °C range	35 °C		35 °C
	43 Forced operation	430 Exit					
		431 ON/OFF		turn forced operation ON/OFF	OFF		OFF
		432 Limit temperature		select temperature limit in 5-450 °C range	250 °C		50 °C
	44 Alarm	440 Exit					
		441 ON/OFF		turn alarm ON/OFF	OFF		OFF
442 Limit temperature			select temperature limit in 25-450 °C range	450 °C		450 °C	
443 Alarm delay			Select delay-length of limit temperature alarm: 0-60 second range	5		5	













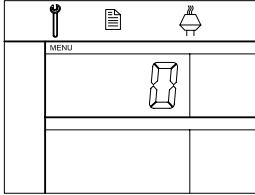

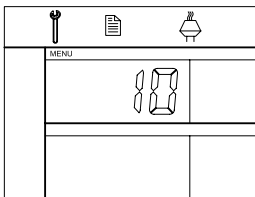

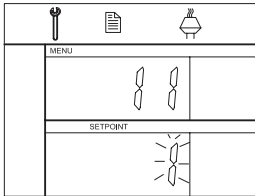



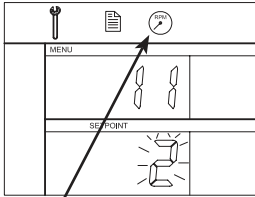

**Important: Menu 4 must only be used for solid fuel!**

### 1.7.2 Changing between the operating functions ( - - )

#### Default operating function

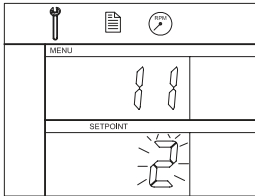
As its base function, the EBC22 is factory set to pressure-controlled regulation of **exodraft** chimney fans (operating function 1  )

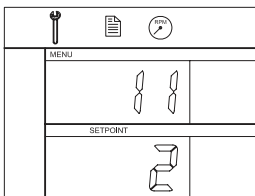
#### How to change the operating function

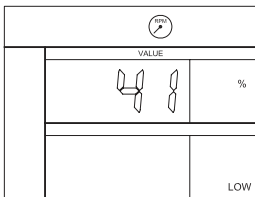
Step	Action...	The display shows...									
1	<ul style="list-style-type: none"> <li>Press and hold  for 3 seconds</li> </ul>										
2	<ul style="list-style-type: none"> <li>Press  to go to menu 1.</li> <li>Press  to go to menu 10.</li> </ul>										
3	<ul style="list-style-type: none"> <li>Press  to go to menu 11</li> <li>Press </li> </ul>										
4	<p>Press  until the symbol and number for the operating function you require is displayed. The three operating functions are:</p> <table border="1" data-bbox="233 1265 1048 1456"> <tbody> <tr> <td>1</td> <td>Pressure-controlled regulation of <b>exodraft</b> chimney fans (default)</td> <td></td> </tr> <tr> <td>2</td> <td>2-stage speed regulation of <b>exodraft</b> chimney fans</td> <td></td> </tr> <tr> <td>3</td> <td>Pressure-controlled regulation of <b>exodraft</b> supply air fan</td> <td></td> </tr> </tbody> </table>	1	Pressure-controlled regulation of <b>exodraft</b> chimney fans (default)		2	2-stage speed regulation of <b>exodraft</b> chimney fans		3	Pressure-controlled regulation of <b>exodraft</b> supply air fan		 <p>symbol is changed</p>
1	Pressure-controlled regulation of <b>exodraft</b> chimney fans (default)										
2	2-stage speed regulation of <b>exodraft</b> chimney fans										
3	Pressure-controlled regulation of <b>exodraft</b> supply air fan										
5	<ul style="list-style-type: none"> <li>Press  to confirm selection (the display blinks faster)</li> </ul>										
6	<ul style="list-style-type: none"> <li>Within 5 seconds, press  again, to save selection. (display stops blinking).</li> </ul>										
7	<ul style="list-style-type: none"> <li>To finish and return to the operation screen, press </li> </ul>										



## 2. Pressure-controlled regulation of the chimney fan

### 2.1 Use

#### Area of use

- The EBC22 is designed for use with boiler systems with 1- and 2-stage burners.
- The EBC22 can also be used for boiler systems with modulating burners.
- The EBC22 can also be used for multiple boiler systems
- The control system is intended for:
  - ♦ solid fuel boilers,
  - ♦ atmospheric gas boilers
  - ♦ forced draft boilers for oil and gas
  - ♦ condensing boilers.
- The EBC22 can control a chimney fan directly or indirectly via a frequency converter.

### 2.2 Method of operation

#### General function

- The control system monitors chimney draft and disconnects the burner in the event of errors (the alarm-diode on the EBC22 will turn on).
- When the boiler thermostat demands heat, the chimney fan will start at max. voltage, the burner start is delayed
- When the EBC22 registers sufficient chimney draft, the burner is released.
- The EBC22 maintains the set pressure by regulating the voltage. The pressure is shown in the display.
- In the event of an insufficient pressure the burner will be disconnected after 15 seconds. "Insufficient pressure" is less than 64% of the set value, corresponding less than 80% flow.
- When the boiler switches off, the chimney fan is also stopped. However, it is possible to set a post-purge period for the chimney fan (see page 21). Alternatively, the control system can be set up to keep the chimney fan running continuously (see page 19).

#### Light emitting diodes and output signals

All inputs and outputs are linked to light emitting diodes for the monitoring and service of the system (1.4.2 Light emitting diodes and terminal board, page 8).

The EBC22 has 0–10V output signals for controlling multiple chimney fans via frequency converters or motor power relays.

### 2.3 Electrical connection



This work must be performed by a qualified electrical engineer, in accordance with locally applicable rules and legislation.



The installation of the supply cable must be carried out in accordance with applicable regulations and legislation.

The earth terminal (  ) must always be connected.

When connecting pressure transducer (XTP) and frequency converter, screened cable must be used.



#### Isolation switch

**exodraft** stresses that according to EU's Machinery Directive an isolation switch must be set up in the fixed installation.

The isolation switch is not supplied by **exodraft**. Available as an extra.



## 2.4 Sample wiring diagrams

As a constant pressure regulator for **exodraft** chimney fans, the EBC22 can be connected to a range of different signals. The following pages are sample wiring diagrams, and show the following:

- **2.4.1 Single- or two boiler application, page 17**
- **2.4.2 Single boiler application with potential free contact in boiler, page 18**
- **2.4.3 2 boiler application with continuous operation of chimney fan, page 19**
- **2.4.4 Solid fuel boiler with temperature sensor, page 20**



**Contact the boiler manufacturer for details of correct connection of the boiler control system.**





## 2.4.1 Single- or two boiler application

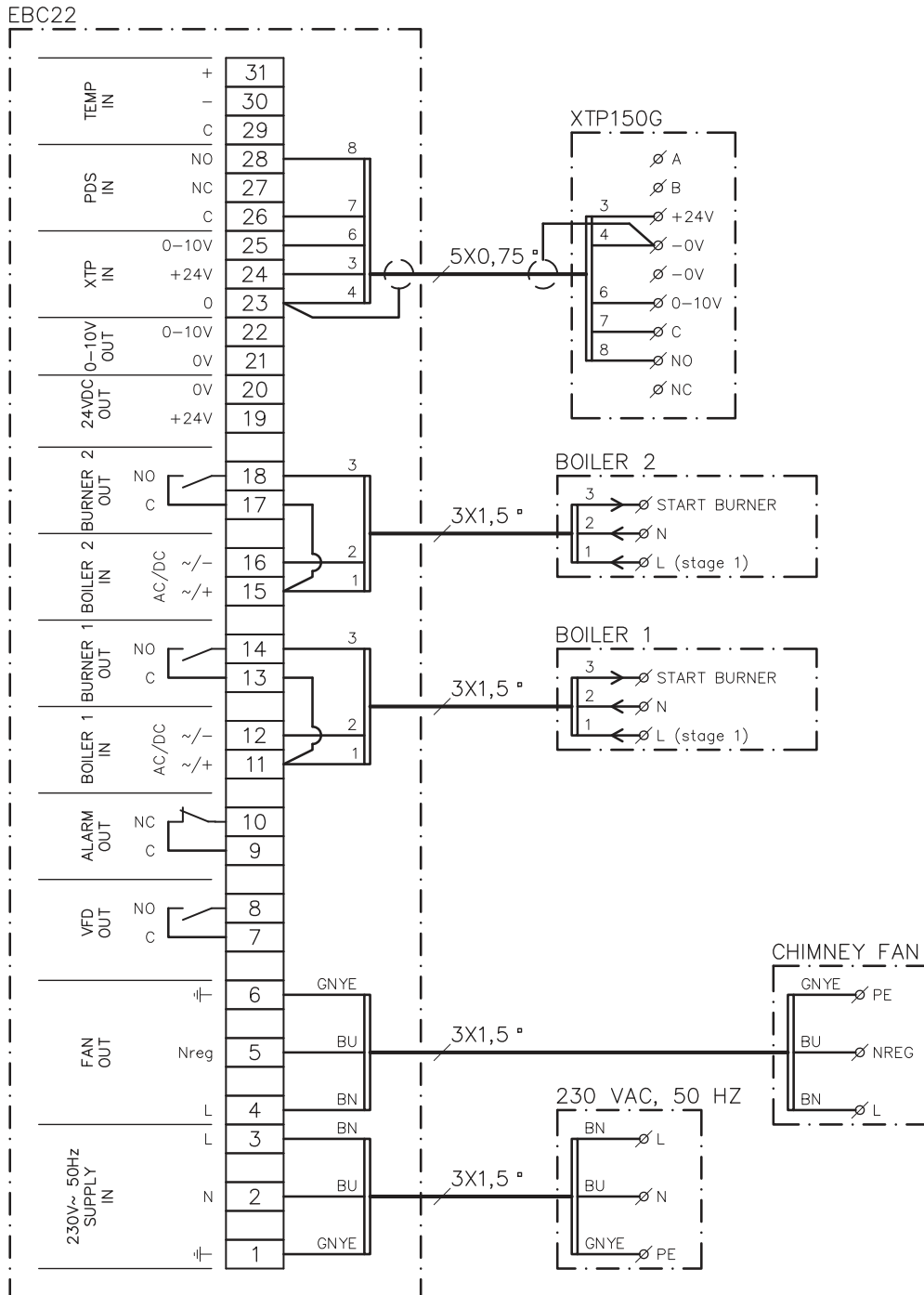

This example shows how to connect a voltage signal (10–230V AC/DC) for the EBC22 to start/stop the fan from one or two independent boilers:

- Connect the supply voltage to terminals 1–3
- Connecting the boilers:
  - ♦ Connect the burner start signal (L) to terminal 11 & 15
  - ♦ Connect the neutral wire to terminal 12 & 16
  - ♦ The start signal for the burner is sent from terminal 14 & 18
- Loop terminals 11 and 13
- Loop terminals 15 and 17
- Connect the chimney fan to terminals 4–6
- Connect the pressure transducer (XTP) to terminals 23–28



## 2.4.2 Single boiler application with potential free contact in boiler

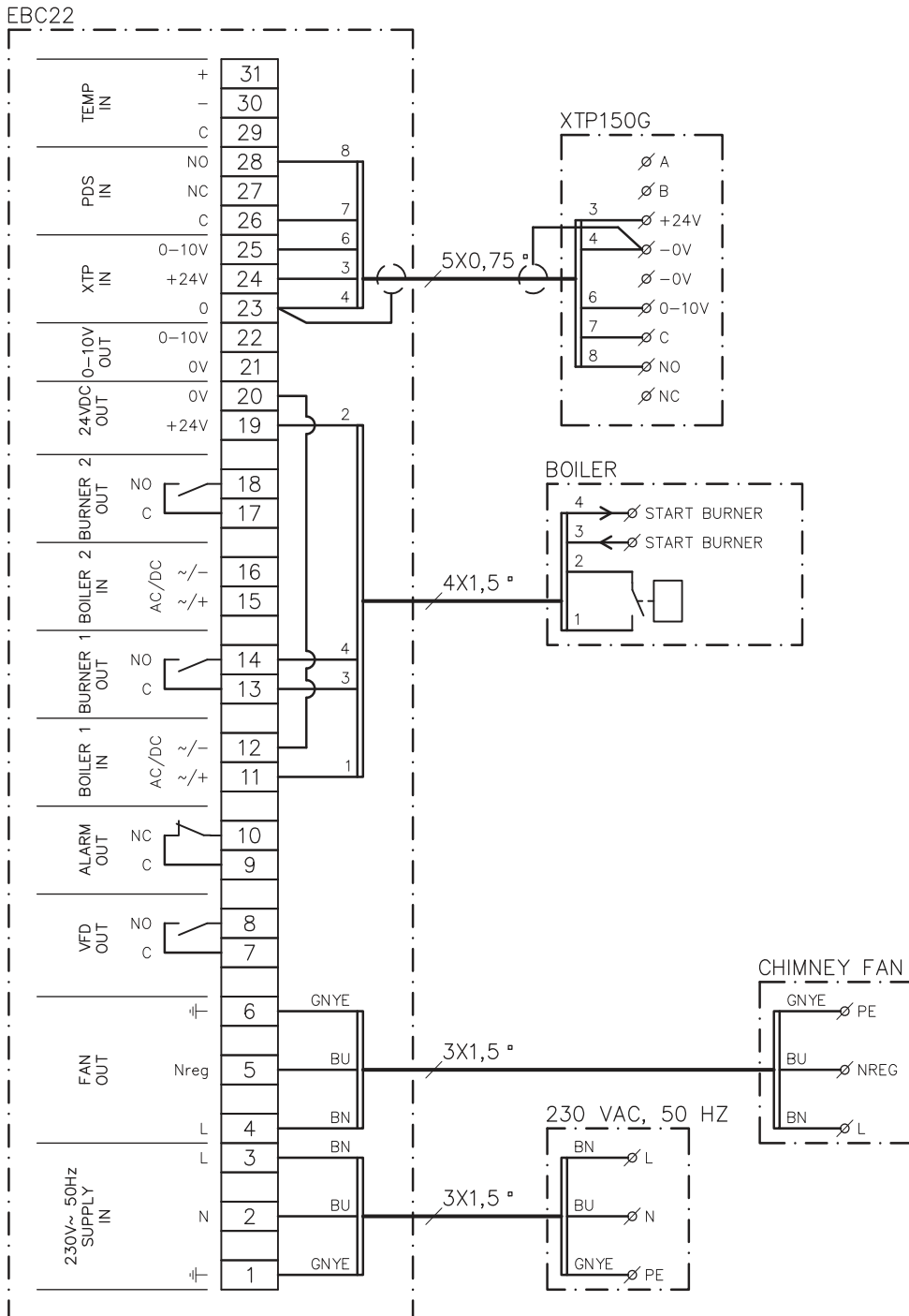

This example shows how to connect a potential free contact to the EBC22 to start/stop the fan:

- Connect the supply voltage to terminals 1–3.
  - ♦ Connection to the boiler:
  - ♦ Connect the potential free contact to terminals 11 & 19.
  - ♦ Loop terminals 12 & 20.
- Connect the burner start signal to terminals 13 & 14.
- Connect the chimney fan to terminals 4–6.
- Connect the pressure transducer (XTP) to terminals 23–28.



### 2.4.3 2 boiler application with continuous operation of chimney fan

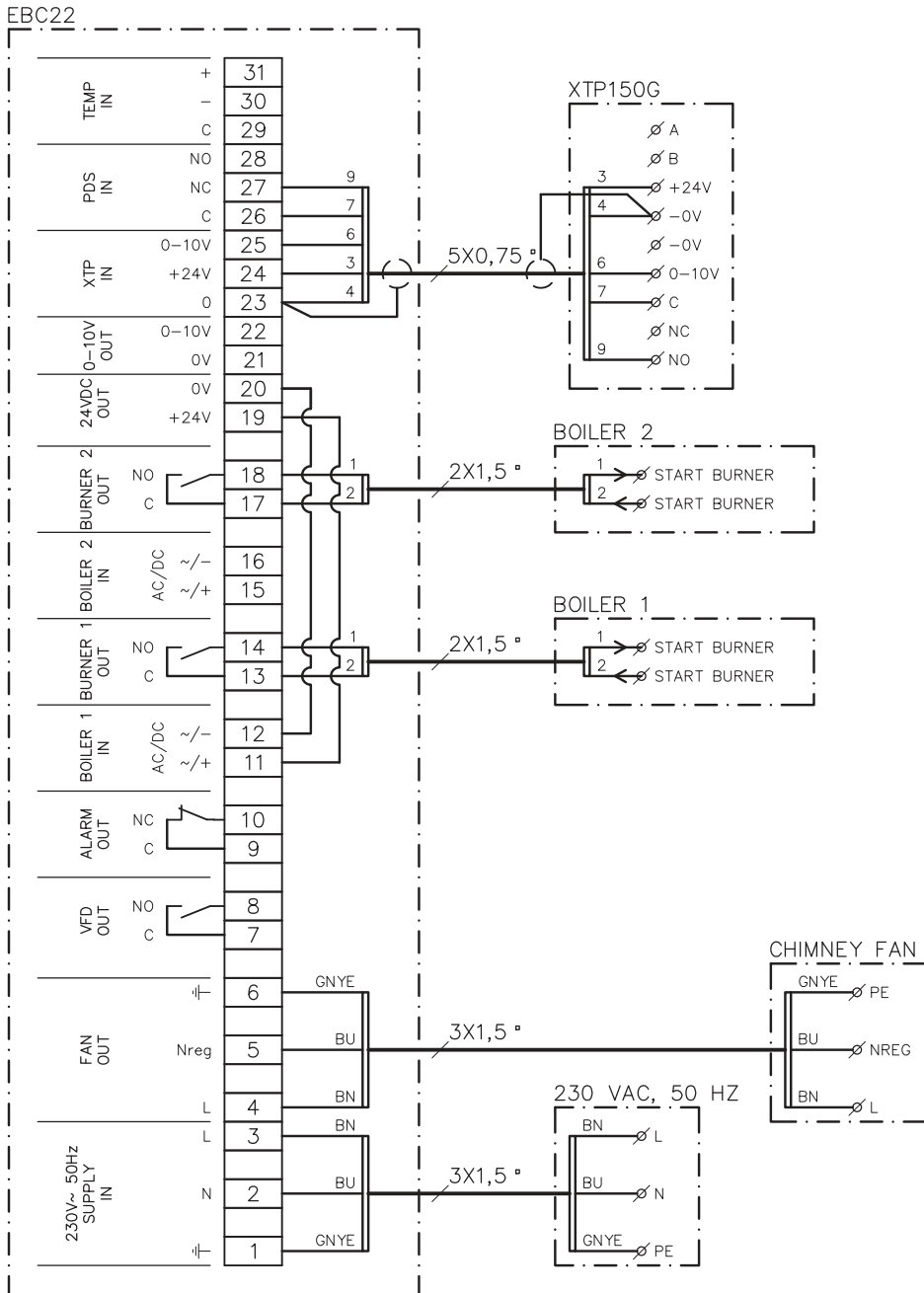

This example shows how to connect the EBC22 if you require continuous operation of the chimney fan from one or two boilers:

- Connect the supply voltage to terminals 1–3.
- Loop terminals 11 & 19.
- Loop terminals 12 & 20.
- Connection to boiler (example with 2 boilers):
  - ♦ Connect the boiler 1 start signal to terminals 13 & 14.
  - ♦ Connect the boiler 2 start signal to terminals 17 & 18.
- Connect the chimney fan to terminals 4–6.
- Connect the pressure transducer (XTP) to terminals 23–28.



### 2.4.4 Solid fuel boiler with temperature sensor

Showing how a fan is started and stoped via a temperature sensor in the flue duct.

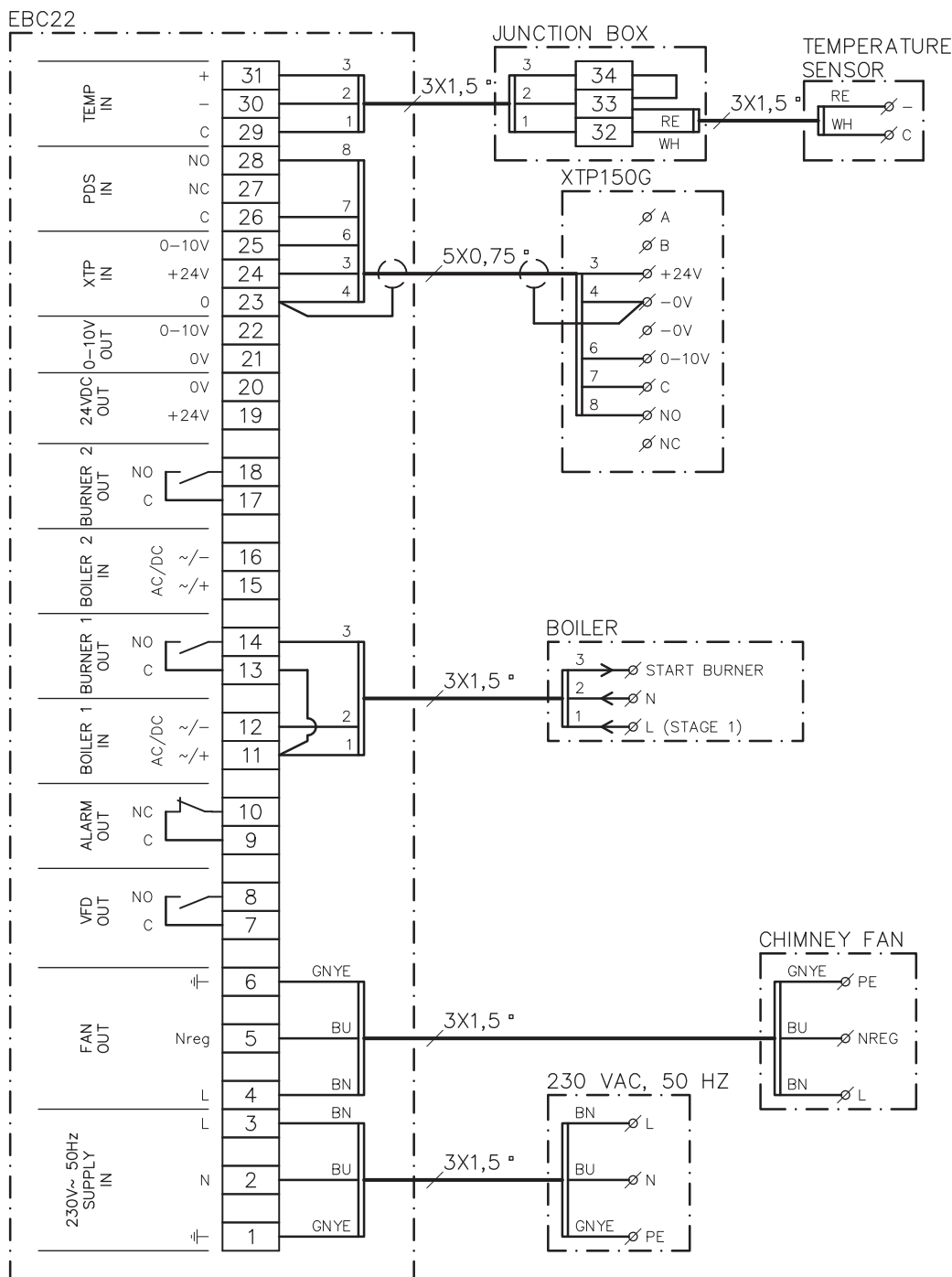

Example showing how a fan start/stop temperature sensor is connected to the EBC22.

- Connect the supply voltage to terminals 1–3
- Connecting the boiler:
  - ♦ Connect the burner start signal (L) to terminal 11.
  - ♦ Connect the neutral wire to terminal 12.
  - ♦ Loop terminals 11 and 13.
  - ♦ The start signal for the burner is sent from terminal 14
- Connect the fan to terminals 4-6.
- Connect the pressure transducer (XTP) to terminals 23–28.
- Connect the temperature sensor through a junction box to terminals 29-31



## 2.5 User menu

### 2.5.1 Layout of the user menu

The user menu consists of a single level and provides access to 4 parameters:

Menu	Function	Range
1	Setting the required pressure	Depending on the XTP-range set in menus 151 and 152
2	Setting pre-purge period	0-999 s
3	Setting post-purge period	0-60 min
4	Displaying current alarm (see alarm overview page 34)	-

When the instructions refer to the menu numbers 1,2,3 and 4 it is understood that these numbers refer to the user menus.

### 2.5.2 Operating the user menu

Adjust the set point for user menu items 1–4 in the same way as shown in the example in page 10

To operate menu items 1–4, use the buttons as follows:

Step	Press...	To...
1		Activate the user menu
2	and	Go to the menu item you wish to edit
3		Edit the menu item selected
4	and	Adjust the required set point
5		Confirm the required set point
6		To save the required set point: Press OK again within 5 seconds
7		Return to operation screen. NB: If you do not press  the EBC22 will automatically return to the operation screen after 30 seconds

You can always undo an action (that you have not confirmed by pressing ) and return to the operation screen by pressing .

### Alarms

For alarm handling (menu 4), see page 33

## 2.6 Set-up

For setting up the EBC22, see section 1.6 Set-up, page 10









## 2.7 Commissioning

Commissioning on the EBC22 must be carried out to ensure a correct draft from the system.



Commissioning should be carried out by staff with the appropriate training, and with the authorisation to do so according to local legislation.

Do as follows:

Step	Action...
1	Provisional draft setting (negative pressure): <ul style="list-style-type: none"> <li>• Press  to go to Menu 1.</li> <li>• Press .</li> <li>• Press  or  until the negative required pressure appears in the display.</li> <li>• Press  to confirm the set point.</li> <li>• To save the set point: Press  again within 5 seconds.</li> <li>• Press  to return to the operation screen.</li> </ul>
2	<ul style="list-style-type: none"> <li>• Start the system.</li> <li>• Wait until the boiler starts and the draft has stabilised. The current draft will be shown in the display.</li> </ul>
3	Final adjustment of draft: <ul style="list-style-type: none"> <li>• Check the draft on the boiler.</li> <li>• If draft is not correct, repeat the procedure from step 1.</li> </ul>
4	Check that the monitoring system shuts off the boiler. To simulate an error situation, disconnect the hose from the pressure transducer (XTP). Burner is switched off (diode switches off) and the alarm diode illuminates.
5	After completing the commissioning, check the start-up function by restarting the system.

For the set point values, please refer to the data for the boiler in question. However, the following values can be considered typical:

- Boilers with forced draft: typically 20–30 Pa
- Boilers with atmospheric burners: typically 5–10 Pa

Set up according to site conditions can be determined by boiler commissioning engineer

## 3. 2-stage speed regulation of exodraft chimney fan

### 3.1 Use

#### Area of use

- The EBC22 can be used as a 2-stage speed regulator for an **exodraft** chimney fan.
- The control system is intended for 1- or 2-stage atmospheric gas boilers.
- The EBC22 can control a chimney fan directly or indirectly via a frequency converter.

### 3.2 Method of operation

#### General function

- The EBC22 monitors chimney draft and disconnects the boilers in the event of errors (the alarmdiode on the EBC22 will turn on).
- When the boiler thermostat demands heat, the chimney fan will start at max. voltage.
- When the monitoring system measures sufficient chimney draft, the burner is released, and voltage to the chimney fan is regulated according to the setpoint for stage 1 (LOW).
- When stage 2 (HIGH) is activated, the EBC22 regulates the voltage to the chimney fan according to the set point for stage 2.
- It is possible to set pre-purge and post-purge periods for the chimney fan.
- In the event of insufficient draft, the burner will be disconnected after 15 seconds. "Insufficient draft" is draft less than the value set on the PDS during commissioning.

#### Step-up function

- The step-up function in the EBC22 prevents unintentional disconnection of the system on account of changes in wind and weather conditions.
- The step-up function performs a stepped increase of the voltage as a result of protracted draft errors. In principle, this can be repeated until maximum voltage has been reached.

### 3.3 Electrical connection



This work must be performed by a qualified electrical engineer, in accordance with locally applicable rules and legislation.



The installation of the supply cable must be carried out in accordance with applicable regulations and legislation.

The earth terminal (  ) must always be connected.

#### Isolation switch



**exodraft** A/S stresses that in accordance with EU's Machinery Directive an isolation switch must be set up in the fixed installation.

The isolation switch is not supplied by **exodraft**. Available as an extra.

### 3.4 Sample wiring diagrams

As a 2-stage speed regulator for **exodraft** chimney fans, the EBC22 can be connected to a range of different signals. The following sections contain two sample wiring diagrams showing:

#### 3.4.1 1 x 2-stage boiler, page 24

#### 3.4.2 2 x 1-stage boilers, page 25



**exodraft** recommends that you contact the boiler manufacturer for details of correct connection of the boiler control system.



### 3.4.1 1 x 2-stage boiler

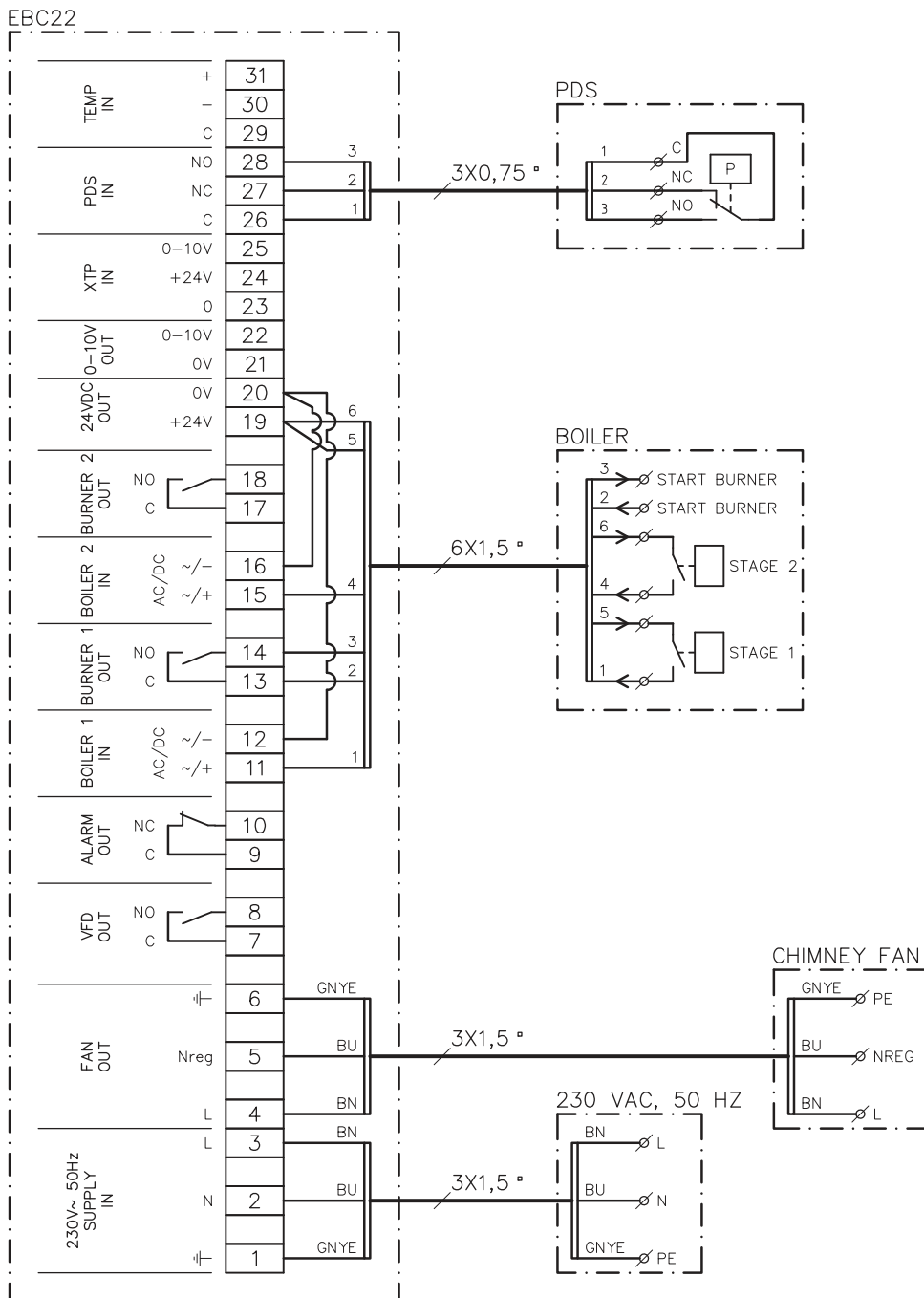

This example shows which inputs/outputs on the EBC22 need to be connected to a 2-stage boiler: The boiler outputs for stages 1 & 2 are two potential free contact sets.

Connect the supply voltage to terminals 1–3.

- Loop terminals 12 & 20.
- Loop terminals 16 & 20.
- Connection to the boiler:
  - ♦ Connect stage 1 (potential free contact) to terminals 11 and 19.
  - ♦ Connect stage 2 (potential free contact) to terminals 15 and 19.
  - ♦ Connect the burner start signal to terminals 13 & 14.
- Connect the chimney fan to terminals 4–6.
- Set the value in menu 31 to 1 (PDS connected).

NB: If <sup>PDS</sup>AUX is flashing, the EBC22 is preparing for a PDS-check.



### 3.4.2 2 x 1-stage boilers

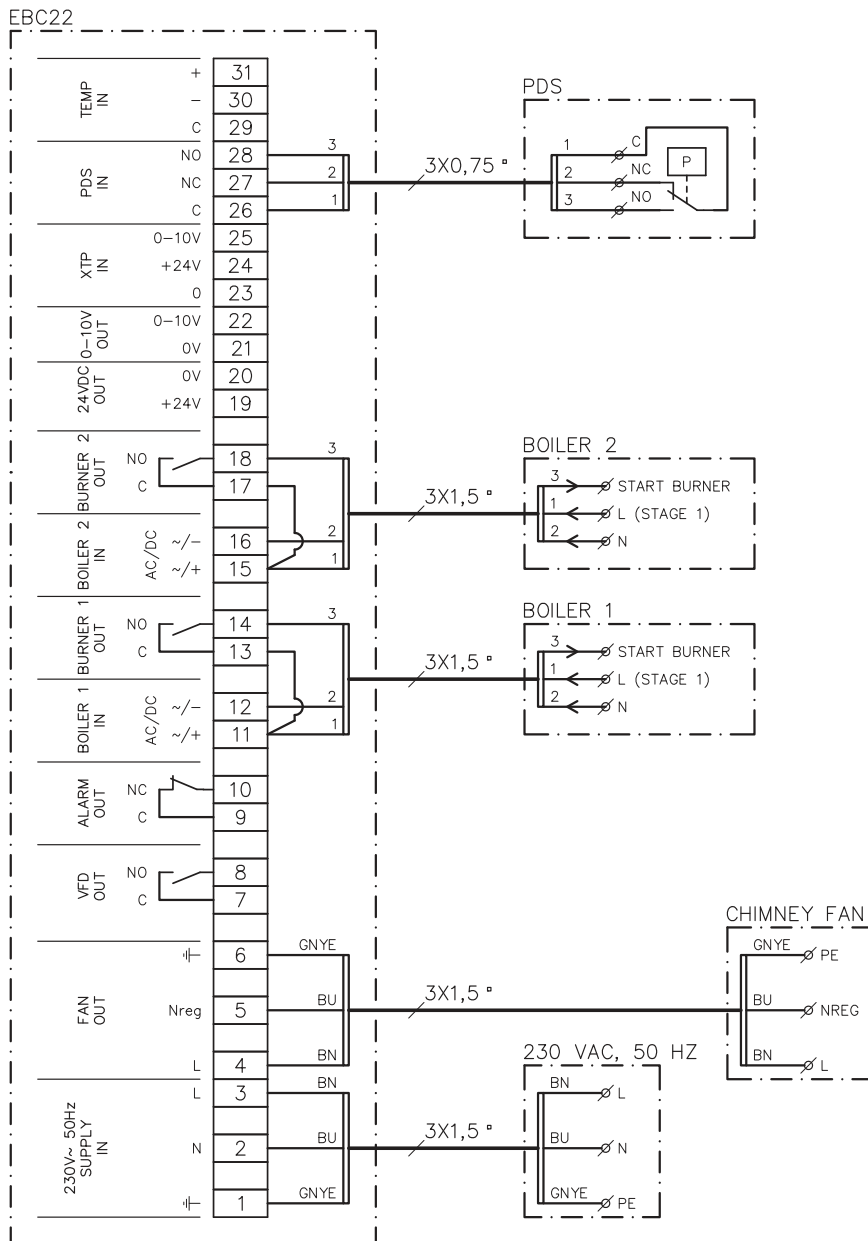

This example shows which inputs/outputs on the EBC22 need to be connected to 2 x 1-stage boilers. The boiler output for stage 1 is a voltage signal.

- Connect the voltage to terminals 1–3.
- Loop terminals 11 & 13.
- Loop terminals 15 & 17.
- Connection to the boilers:
  - ♦ The start signal for the burner from boiler 1 is connected to terminal 14.
  - ♦ Connect boiler 1 (N) to terminal 12.
  - ♦ Connect the start signal for boiler 1 (L) to terminal 11.
  - ♦ The start signal for the burner from boiler 2 is connected to terminal 18.
  - ♦ Connect boiler 2 (N) to terminal 16.
  - ♦ Connect the start signal for boiler 2 (L) to terminal 15.
- Connect the chimney fan to terminals 4–6.
- Adjust the value in menu 31 to 1 (PDS connected).

<sup>PDS</sup>  
NB: If AUX is flashing, the EBC22 is preparing for a PDS-check.



## 3.5 User menu

### 3.5.1 Layout of the user menu

The user menu provides access to 5 functions:

Menu	Function	Range
1	Setting of the chimney fan output for stage 1 (LOW)	35-100%
2	Setting of the chimney fan output for stage 2 (HIGH)	35-100%
3	Setting the pre-purge period for the chimney fan	0-999 s
4	Setting the post-purge period for the chimney fan	0-60 min
5	Displaying current alarm (see alarm overview page 34)	-

When the instructions refer to the menu numbers 1, 2, 3, 4 and 5 it is understood that these numbers refer to the user menus.

### 3.5.2 Operating the user menu

#### Setting up the operating function

Before you can use the EBC22 as a 2-stage speed regulator for **exodraft** chimney fans, you must change the operating function.

The procedure for setting up the operating function is described on page 14

#### Using the buttons

To operate menu items 1–5, use the buttons as follows:

Step	Press...	To...
1		Activate the user menu
2	and	Go to the menu item you wish to edit
3		Edit the menu item selected
4	and	Adjust the required set point
5		Confirm the required set point
6		To save the required set point: Press  again within 5 seconds
7		Return to operation screen. NB: If you do not press  the EBC22 will automatically return to the operation screen after 30 seconds

You can always undo an action (that you have not confirmed by pressing ) and return to the operation screen by pressing .

Adjust the set points for user menu items 1–4 as shown in the example on the following page.

#### Alarms

For alarm handling (menu 5), see page 33

### 3.6 Set-up

**NB**

Remember to set up the operating function of the EBC22 as described on page 14

#### 3.6.1 Setting the chimney fan output

Use the following procedure to adjust the chimney fan output:

Step.	Action...	The display shows...
1	<ul style="list-style-type: none"> <li>Press <b>OK</b> to go to menu 1. The output for stage 1 (LOW) will be displayed.</li> </ul>	
2	<ul style="list-style-type: none"> <li>Press <b>OK</b></li> </ul>	
3	<ul style="list-style-type: none"> <li>Press <b>←</b> and <b>→</b> until the output you require for stage 1 (LOW) (in this example 41%) is displayed.</li> <li>Press <b>OK</b> to confirm the set point</li> <li>Within 5 seconds, press <b>OK</b> again, to save the set point</li> </ul>	
4	<p><i>Only for 2-stage systems:</i></p> <ul style="list-style-type: none"> <li>Press <b>→</b> to go to menu 2 and the settings for stage 2 (HIGH).</li> </ul>	
5	<ul style="list-style-type: none"> <li>Repeat steps 2–3 of the procedure, only this time use them to regulate stage 2.</li> <li>To finish, press <b>RESET</b>.</li> </ul>	

**NB**

If you do not press any buttons for 30 seconds, the EBC22 will automatically switch back to the operation screen.









### 3.7 Commissioning

Commissioning must be carried out on the EBC22 to ensure a correct draft from the system.



Commissioning should be carried out by staff with the appropriate training, and with the authorisation to do so according to local legislation.

Do as follows:

Step	Action...
1	Setting chimney fan stage 1 (LOW) <ul style="list-style-type: none"> <li>• Press  to go to Menu 1.</li> <li>• Press .</li> <li>• Press  or  to set the "LOW" value to max (100%).</li> <li>• Press  to confirm the set point.</li> <li>• To save the set point: Press  again within 5 seconds.</li> <li>• Press  to return to the operation screen.</li> </ul>
2	<ul style="list-style-type: none"> <li>• Start the system on stage 1.</li> </ul>
3	<ul style="list-style-type: none"> <li>• Wait until the PDS is connected (PDS diode lights green).</li> </ul>
4	<ul style="list-style-type: none"> <li>• Access menu 1 as described in step 1.</li> <li>• Slowly adjust "LOW" to the correct draft.</li> <li>• If the PDS shows an error (the alarm diode and  flashes), adjust the setting of the PDS.</li> </ul>
5	<i>Only for 2-stage systems:</i> <ul style="list-style-type: none"> <li>• Start the system on stage 2.</li> <li>• Access menu 2 and slowly adjust "HIGH" to the correct draft.</li> <li>• Both boiler thermostats 1 and 2 must be connected (the BOILER 1 IN and BOILER 2 IN diodes light green).</li> </ul>
6	Check that the monitoring system shuts down the boiler. If necessary, you can simulate an error condition by disconnecting the hose from the negative terminal on the PDS.
7	After completing the commissioning, check the start-up function.

Refer to the boiler manufacturer's technical data for relevant pressure requirements and adjust the %-values accordingly. However the following value can be considered typical:

Boilers with atmospheric burners: typically 5–10 Pa

## 4. Pressure-controlled regulation of exodraft supply air fan

### 4.1 Use

#### General

- The EBC22 can be used to control an **exodraft** BESB or BESF box fan.
- The EBC22 can control a supply air fan directly or indirectly via a frequency converter.

#### Positioning

Fit the EBC22 and pressure transducer (XTP) in the boiler room as described in section 1.3 Fitting, page 5

### 4.2 Method of operation

#### General function

- The control system monitors the pressure in the boiler room and disconnects the burner in the event of errors (the alarmdiode on the EBC22 will turn on).
- When the pressure in the boiler room changes, the EBC22 will change the fan speed in order to meet the setpoint pressure for the boiler room.
- The EBC22 is linked to the boiler system in such a way that when a heating requirement arises, the EBC22 will start the fan and delay the start of the boiler until the pressure in the boiler room is sufficient.
- A safety function ensures that if the pressure in the boiler room is insufficient, the EBC22 will shut down the boilers.

### 4.3 Electrical connection



This work must be performed by a qualified electrical engineer, in accordance with locally applicable rules and legislation.



The installation of the supply cable must be carried out in accordance with applicable regulations and legislation.

The earth terminal (  ) must always be connected.

When connecting pressure transducer (XTP) and frequency converter, screened cable must be used.

#### Isolation switch



**exodraft** stresses that in accordance with EU's Machinery Directive an isolation switch must be set up in the fixed installation.

The isolation switch is not supplied by **exodraft**. Available as an extra.

### 4.4 Sample wiring diagram

The following sample wiring diagram shows how to connect the EBC22 to a frequency converter/MPR relay.



**exodraft** recommends that you contact the boiler manufacturer for details of correct connection of the boiler control system.

### 4.4.1 Connection of frequency converter/MPR relay

This example shows which inputs/outputs on the EBC22 need to be connected to the frequency converter/MPR relay.

- Connect the supply voltage to terminals 1–3.
- Loop terminals 12 & 20.
- Connection to the boiler:
  - ♦ Connect the burner start signal to terminals 13 & 14.
  - ♦ Connect the potential free contact to terminals 11 & 19.
- Frequency converter:
  - ♦ Connect terminals 7 & 8 to the start/stop input on the frequency converter.
  - ♦ Connect terminals 21 & 22 to the frequency converter input for external speed regulation.
- Connect the pressure transducer (XTP) to terminals 23–28.

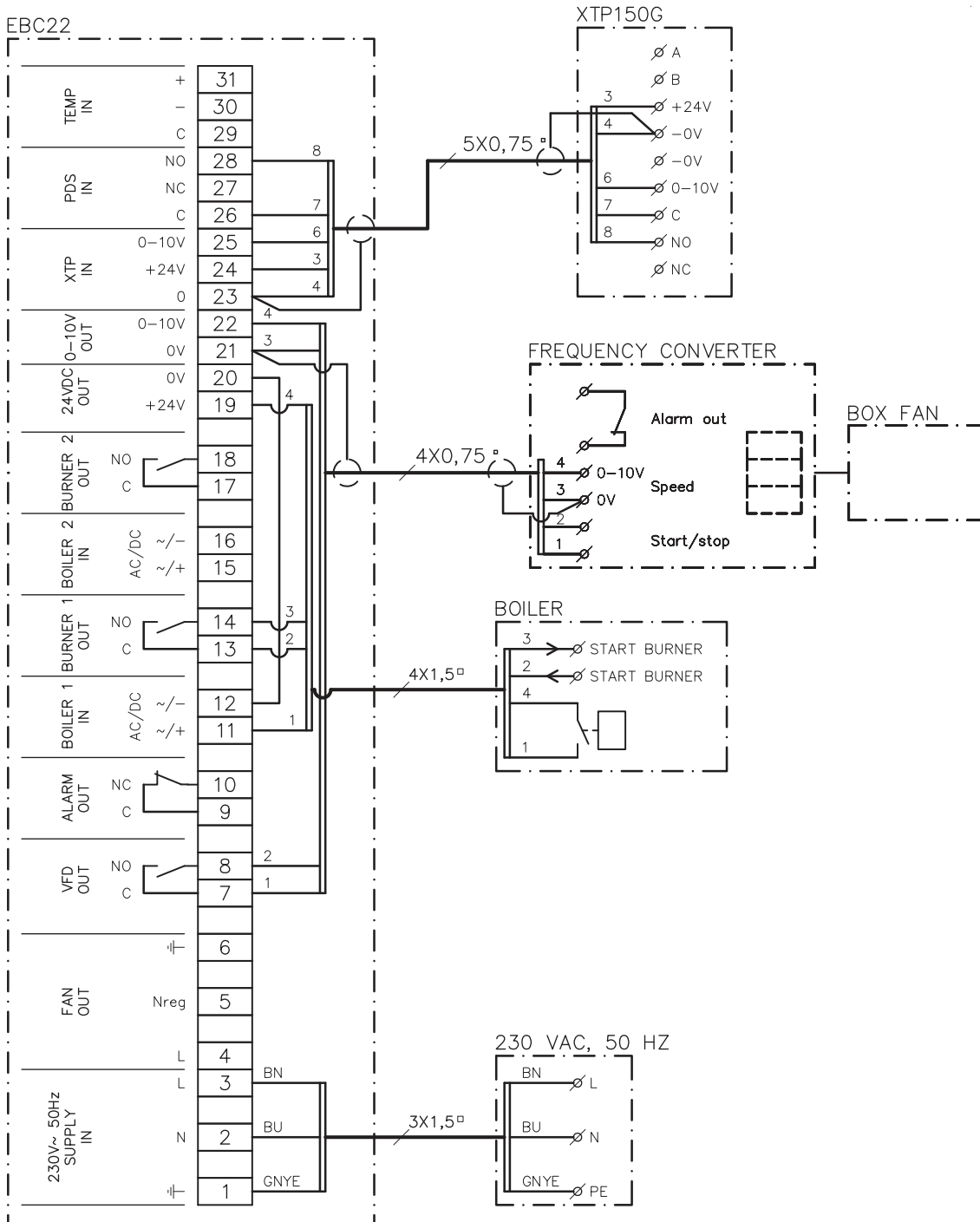

## 4.5 User menu

### Layout of the user menu

The user menu consists of a single level and provides access to 4 parameters:

Menu	Function	Range
1	Setting the required pressure	Depending on the XTP-range set in menus 151 and 152
2	Setting the pre-purge period for the fan	0-999 s
3	Setting the post-purge period for the fan	0-60 min
4	Displaying current alarm (see alarm overview page 34)	-

When the instructions refer to the menu numbers 1, 2, 3 and 4 it is understood that these numbers refer to the user menus.











### 4.5.1 Operating the user menu



#### Setting up the operating function

Before you can use the EBC22 for pressure controlled regulation of **exodraft** supply air fans, you will have to change the operating function.

For setting up the operating function, see page 14

#### Using the buttons

Step	Press ...	To ...
1		Activate the user menu
2	 and 	Go to the menu item you wish to edit
3		Edit the menu item selected
4	 and 	Adjust the required set point
5		Confirm the required set point
6		To save the required set point: Press OK again within 5 seconds
7		Return to operation screen. NB: If you do not press  the EBC22 will automatically return to the operation screen after 30 seconds

You can always undo an action (that you have not confirmed by pressing ) and return to the operation screen by pressing .

Adjust the set points for user menu items 1–4 as shown in the example on the following page.



#### Alarms

For alarm handling (menu 4), see page 33

## 4.6 Set-up

### Setting the pressure

To set up the EBC22, do the following:

Step	Action...
1	<ul style="list-style-type: none"> <li>Follow the procedure on page 14 for changing the operating function into pressure-controlled regulation of an <b>exodraft</b> supply air fan, ( operating function 3).</li> </ul>
2	<ul style="list-style-type: none"> <li>Follow the procedure page 10 (1.6) for setting the required pressure in the boiler room. The procedure is the same as for setting a chimney draft. The only difference is that the  symbol is shown in the display on completion of step 1. Set the pressure in accordance with locally applicable requirements.</li> </ul>







## 4.7 Commissioning

Commissioning of the EBC22 must be carried out so that the supply air fan ensures correct pressure in the room.



Commissioning should be carried out by staff with the appropriate training, and with the authorisation to do so according to local legislation.

Do as follows:

Step	Action...
1	Provisional setting of the pressure in the boiler room <ul style="list-style-type: none"> <li>Press  to go to Menu 1.</li> <li>Press .</li> <li>Press  and  to adjust the value until the required pressure is shown in the display.</li> <li>Press  to confirm the set point.</li> <li>To save the set point: Press  again within 5 seconds.</li> <li>Press  to return to the operation screen.</li> </ul>
2	Start the boiler system at max. output.
3	Check that the control system regulates to the set point.
4	Check the safety monitoring.
5	<ul style="list-style-type: none"> <li>If appropriate, simulate error conditions by switching off the supply air fan.</li> <li>Burner is switched off (diode switches off) and the alarm diode illuminates.</li> </ul>
	After completing the commissioning, check the start-up function by restarting the system.

For the set point values, please refer to the data for the boiler in question. However,  $\pm 5$  Pa can be considered typical.



## 5. List of alarms and troubleshooting



Some systems require a special start-up procedure following safety shut-down. Follow this procedure before pressing the  button.

### 5.1 Alarm handling

There are two levels of alarm handling:

- Resetting a current alarm (user menu)
- Resetting the alarm log (service menu)

#### 5.1.1 Resetting a current alarm

An alarm situation in the system is indicated by the illumination of the EBC22 alarm diode (see page 7), and by the appearance of the alarm symbol  in the display.



##### Automatic reset

If menu 25 is set to automatic reset (1), the EBC22 will attempt to reset an alarm every 10 seconds. If error persists, check the alarm overview (next page) for solution.

##### Manual reset

If menu 25 is set to manual reset (2), alarms must be manually reset.

In the event of an alarm, undertake the following procedure:

Step	Action...
1	Go to menu 4 (menu 5 for operating function 2,  ) to display the current alarm.
2	Check the alarm overview (next page) to identify the alarm number.
3	Solve the error.
4	<ul style="list-style-type: none"> <li>• Press  to reset the alarm*</li> <li>• The alarm diode will switch off, and the alarm symbol  will disappear from the display.</li> </ul>
5	Restart the system if necessary.
	After completing the commissioning, check the start-up function by restarting the system.

\* The EBC22 will automatically return to the main screen if no buttons are pressed for 30 seconds. If this happens, repeat step 1.

#### 5.1.2 Resetting the alarm log

The alarm log (menus 211–219) is a list of the 9 most recent alarms.

To reset the alarm log, do the following:

Step	Action...
1	Go to menu 22 and select YES.
2	A 10-second countdown will start. Within these 10 seconds, you can cancel your choice by pressing any button. If you do not press any buttons, the alarm log will be reset.
4	<ul style="list-style-type: none"> <li>• Press  to return to the main screen</li> </ul>



### 5.1.3 Alarm overview

The table below presents an overview of the alarms that may occur (the alarm numbers are displayed in the alarm menu).

Alarm	Error type	Solution
A00	No error	
A01	XTP flow alarm Defaults (menu 23):Chimney fan: < 64% of set pressureAir supply fan: > 300% of set pressure	Check: The flue, the chimney and the chimney fan for blockages.The commissioning.That the measuring probe and the spigots on the pressure transducer are not blocked.
A02	PDS check error	Check:The setting of the monitoring unit (the PDS).The connection to the PDS.The PDS's switch function.
A03	PDS error (flow error)	Check that:The PDS is connected.The PDS is correctly adjusted in relation to the set point.Menu 31 has been set correctly (1).
A04	XTP Start Timer error (flow error)	Check:the hose to the pressure transducer.the commissioning,the chimney fan is of sufficient capacity.
A10	XTP not connected	
A11	PDS not connected	Check the PDS connection.
A13	AUX alarm (alarm for terminals 26–28)	Check:the connections to terminals 26–28.the setting in menu 31 (2).the loop between terminals 26 and 28. If XTP150 connected : power off/on the unit. If error persist contact dealer (defective unit).
A14	Temperature sensor not connected	Check:that the temperature sensor is connectedIf the connection is good, then the temperature sensor may be faulty. Change the sensor
A15	Temperature alarm	Inspect unit
A16	24 VDC overloaded	Check the load on terminals 19-20. If error persists, contact dealer (defective unit).
A17	XTP connected (error only for the 2-stage speed regulation function )	Remove the XTP. The XTP must not be fitted in speed-regulation mode.
A18	XTP overload	Check if XTP is defective.
A81	E2prom read failure	<ul style="list-style-type: none"> <li>• Reset to defaults (menu 18).</li> <li>• Turn the EBC22 off.</li> <li>• Restart again.</li> <li>• If error persists, contact dealer (defective unit).</li> </ul>
A82	Error in Safety relay circuit	
A83	Error in Safety relay circuit	
A84	Error in Safety relay circuit	
A85	Safety No HeartBeat	
A86	Safety input circuit error	
A87	Safety input circuit error	
A88	Safety input circuit error	
A89	Faulty heartbeat from safe processor detected	
A91	Temperature sensor not connected	Check that the temperature sensor is connected If the connection is good, then the temperature sensor may be faulty. Change the sensor
A92	Temperature alarm	Inspect unit
A98	Faulty main processor	<ul style="list-style-type: none"> <li>• Reset to defaults (menu 18).</li> <li>• Turn the EBC22 off.</li> <li>• Restart again.</li> <li>• If error persists, contact dealer (defective unit).</li> </ul>
A99	Faulty main processor	

## 5.2 More troubleshooting

### 5.2.1 Program running

If there is doubt about whether the EBC22 is running: Check if the control LEDs are flashing.

To view the control LEDs: Remove the front panel.



This work must be performed by a qualified electrical engineer.

Control LEDs

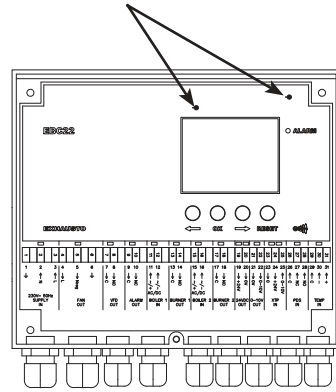

### 5.2.2 Communication error

If the display shows three horizontal lines in the lowest display box:

Press  and repeat the setting

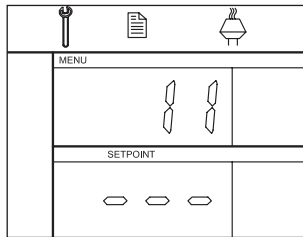

If the error persists, then the EBC22 is faulty. Contact dealer.



## 6. Technical specifications

### General

Height x width x depth:	204.3 mm x 239.5 mm x 77.2 mm
Weight:	1.62 kg
Protection class:	IP54
Casing material:	ABS PA 758 (Acrylnitrile Butadiene Styrene PolyAmide 758)
Supply voltage:	230–240 VAC +/- 10%, 50 Hz +/- 1%
Charging current:	Max. 3A
Fuse:	T4 A
Ambient temperature:	-20°C to 60°C
Regulation range:	-500 Pa to 500 Pa
Wiring from EBC22 to chimney fan / fan	Max. 100 m. shielded cable

### Inputs

Digital inputs (BOILER 1 IN & BOILER 2 IN):	18 to 230 VAC / VDC
Pressure sensor-input (XTP IN):	0 to 10 VDC, 20 mA
Pressure switch input (PDS IN):	24 VDC, 20 mA
Temperature sensor (TEMP IN):	-30°C to +500°C

### Outputs

Digital output relays (BURNER1 OUT & BURNER 2 OUT):	250 VAC, 4A, AC3
Motor regulator (FAN OUT):	Supply voltage -3%, 3A, AC3
Motor start/stop relay (VFD OUT):	250 VAC, 8A, AC3
Control signal 0–10 VDC (0-10V OUT):	20 mA
24 VDC supply (24VDC OUT):	100 mA
Alarm output relay (ALARM OUT):	250 VAC, 8A, AC3

### Pressure transducer (XTP 150G)

Height x width x depth:	90 mm x 115 mm x 55 mm
Protection class:	IP565
Ambient temperature:	-25 °C to 50 °C
Wiring to EBC22	Max. 100 m. shielded cable

---

### Third part approvals

The EBC22 is certified by GASTEC and have the certification number: PIN: 0063BV1148

## 7. EU declaration of conformity

**exodraft a/s**  
**C.F. Tietgens Boulevard 41**  
**DK-5220 Odense SØ**  
**DANMARK**

hereby declares that the following product:

**EBC22**

which is covered by this declaration, is in accordance with the following standards:

**EN 60335-1, EN60335-2-102, EN 61000-6-1, EN 61000-6-2, EN 61000-6-3, EN 301489-1, EN 301489-3,  
EN 300220-1, EN298:2003**

in relation to the provisions of the following directives:

Low Voltage Directive:

**2006/95/EC**

EMC Directive:

**2004/108/EC**

Gas Appliances Directive:

**2009/142/EC**

Odense, 05-08-2013

Managing Director

Jørgen Andersen









---

**DK: exodraft a/s**

C. F. Tietgens Boulevard 41  
DK-5220 Odense SØ  
Tel: +45 7010 2234  
Fax: +45 7010 2235  
info@exodraft.dk  
www.exodraft.dk

**SE: exodraft a/s**

Årnäsvägen 25B  
SE-432 96 Åskloster  
Tlf: +46 (0)8-5000 1520  
Fax: +46 (0)340-62 64 42  
info@exodraft.se  
www.exodraft.se

**NO: exodraft a/s**

Storgaten 88  
NO-3060 Svelvik  
Tel: +47 3329 7062  
Fax: +47 3378 4110  
info@exodraft.no  
www.exodraft.no

**UK: exodraft Ltd.**

Unit 4B, Lancaster Ct.  
Coronation Road  
Cressex Business Park  
GB-High Wycombe HP12 3TD  
Tel: +44 (0)1494 465 166  
Fax: +44 (0)1494 465 163  
info@exodraft.co.uk  
www.exodraft.co.uk

**DE: exodraft GmbH**

Soonwaldstraße 6  
DE-55569 Monzingen  
Tel: +49 (0)6751 855 599-0  
Fax: +49 (0)6751 855 599-9  
info@exodraft.de  
www.exodraft.de